

Installation manual

RJ45-16CAT6-1RU

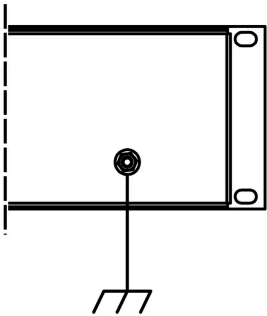

Earthing



Installation

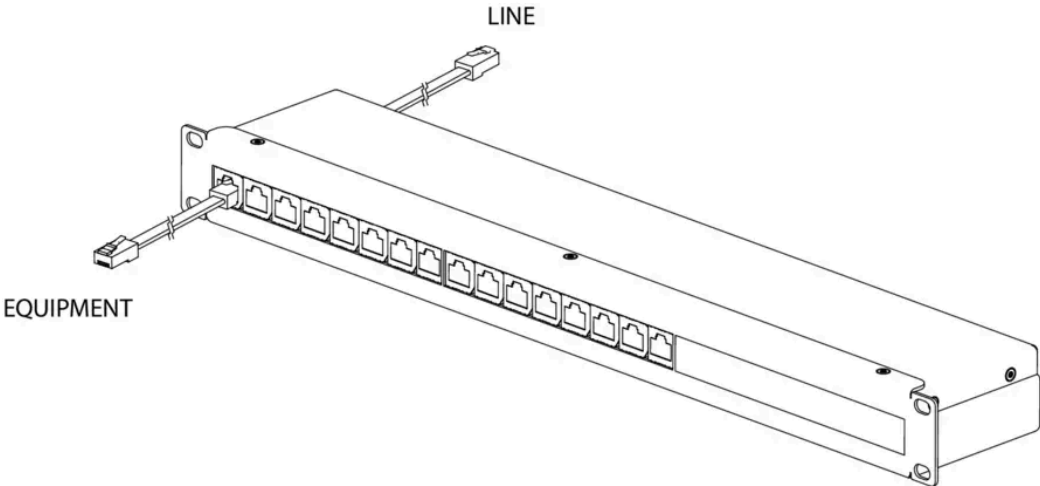



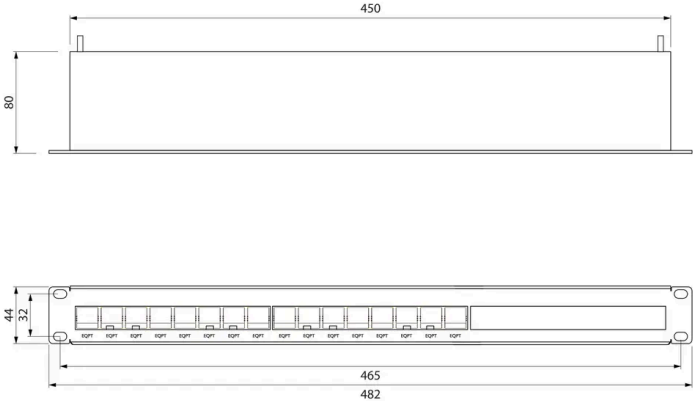

Dimensions



Electrical Specifications

| | | |
|---|---|--------|
| Connection type |  | Series |
| Maximum continuous voltage (DC) | U_c | 6V |
| Maximum discharge current (8/20 μ s) (L-L) | I_{max} | 5kA |
| Maximum common mode discharge current (8/20 μ s) (CM) | I_{max} | 10kA |

Mechanical Specifications

| | | |
|-------------------------------|---|------------|
| Minimum operating temperature |  | -40°C |
| Maximum operating temperature |  | 70°C |
| Minimum operating humidity |  | 5% |
| Maximum operating humidity |  | 95% |
| Mounting method |  | Rack mount |

V1 - Approved - 2026/06/24