

### LCP-18

#### Load Cell Protector

The LCP is a specially designed surge protector for both 4 and 6-wire loadcells. It can also be used to protect the controlling measuring instrument. The LCP is certified for installation in load cell circuits and will not affect the calibration of the loadcells. The LCP comes in an IP67 rated enclosure with internal terminal blocks at each end to make the connections to both the loadcell and the measuring instrument, effectively making a series connection.

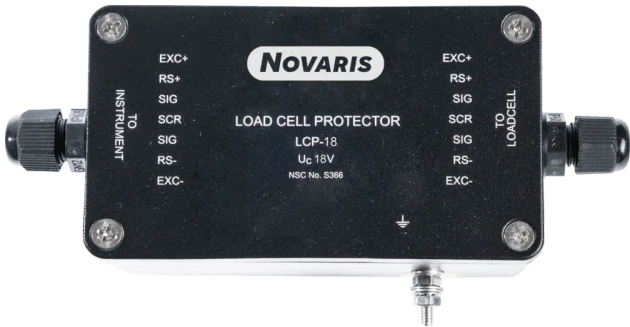
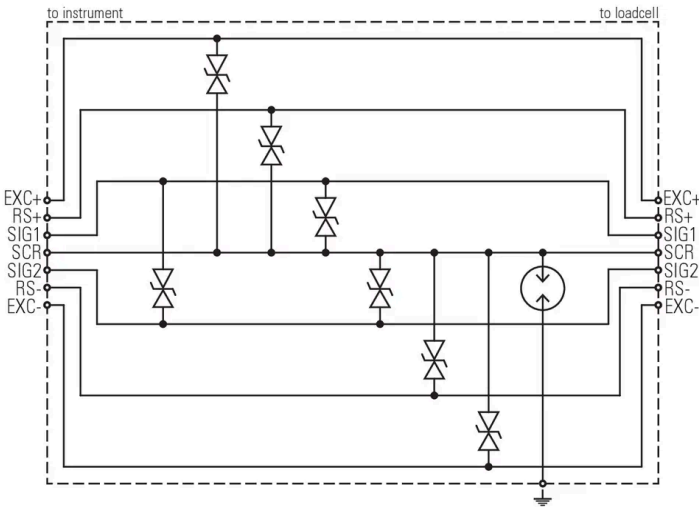
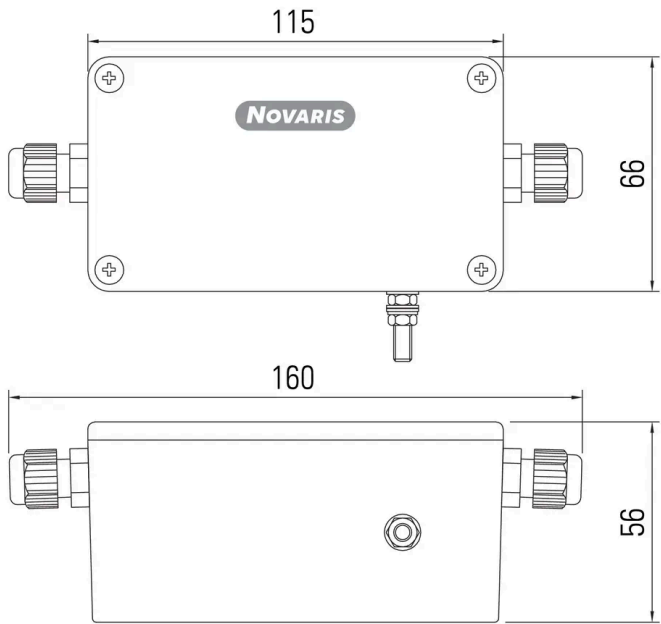

Image for illustrative purposes only

#### Wiring







#### Dimensions



## Product Datasheet

### Electrical Specifications

Connection type		Series
Number of lines		4 or 6
Modes of protection		Transverse and Common
Maximum continuous voltage (DC)	$U_c$	18V
Maximum continuous voltage (AC)	$U_c$	12V
Maximum discharge current (8/20 $\mu$ s)	$I_{max}$	250A
Maximum load current	$I_L$	6.5A
AC durability 5x1s		1A rms
Overstressed fault mode		Mode 2
Response time	$t_A$	<5ns
Line resistance		0.2 $\Omega$
Earthing		M4 SS Stud













### Electrical (L-L) Specifications

Voltage protection level @ 1 kV/ $\mu$ s	$U_p$	45V
--	-------	-----

### Electrical (L-PE) Specifications

Voltage protection level @ 1 kV/ $\mu$ s	$U_p$	350V
--	-------	------

### Mechanical Specifications

Minimum operating temperature		-40°C
Maximum operating temperature		85°C
Minimum operating humidity		5%
Maximum operating humidity		95%
Mounting method		Free standing
Environmental rating		IP67
Enclosure material		Aluminium
Enclosure finish		Black powdercoat
Terminal type		Cage clamp
Terminal capacity		2.5mm <sup>2</sup>
Terminal screw torque		0.5Nm
Length		160mm
Width		66mm
Height		56mm
Dimensional tolerance		0.5mm

### Standard Specifications

IEC 61643-21	SPD connected to telecommunications and signalling networks - Cat C2
AS 1768	Signalling/Telecommunications surge protection
UL 1449 & UL 497B	Protectors for data, communications and fire-alarm circuits
ITU-T K.44	Resistibility tests for telecommunication equipment exposed to overvoltages and overcurrents

### Shipping Specifications

Weight		550g
Customs tariff		85363000, 85363010

### Other Specifications

Product Code		LCP-18
--------------	---	--------