

SG3-50-275

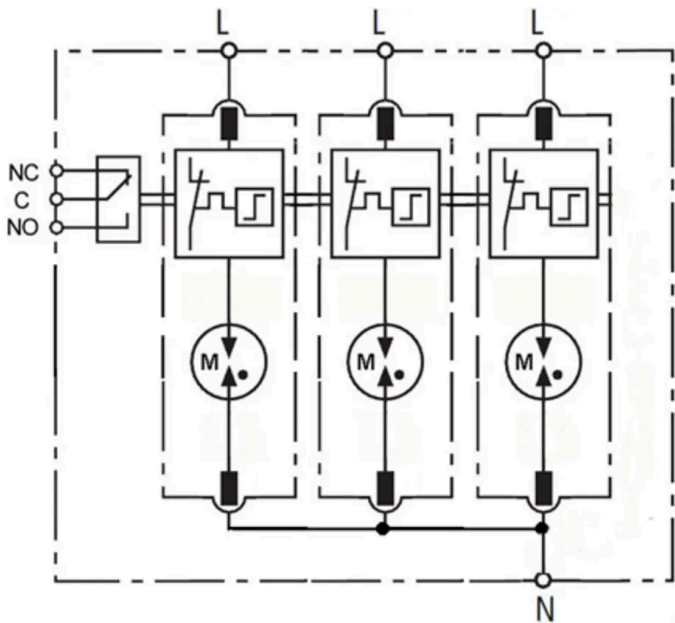
Spark Gap Surge Diverter

Spark Gap Surge Diverters provide point of entry protection for main switchboards where rugged direct strike protection is required. SG products can withstand a continuous overvoltage of 440V, making them ideal for unstable supply conditions where power system faults may occur.

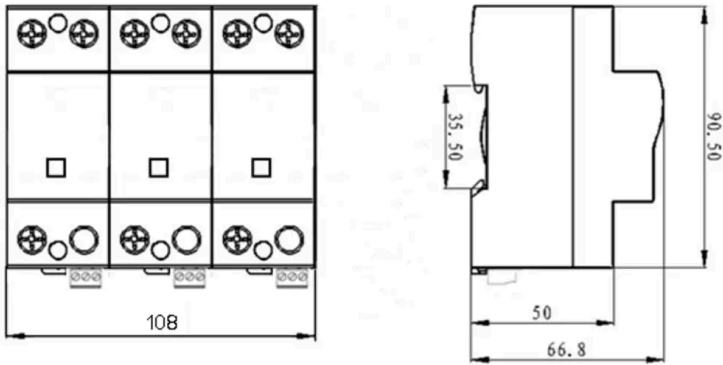


Image for illustrative purposes only

Wiring







Dimensions



Product Datasheet

Electrical Specifications

Connection type		Shunt
Modes of protection		L-N
Number of ports		1
Number of phases		3
Location		Indoor
Nominal voltage	U_0	230VAC
Short circuit withstand level	I_{SCCR}	25kA
Maximum backup fuse		500A
















Electrical (L-N) Specifications

Maximum continuous voltage AC	U_c	275VAC
Maximum discharge current (8/20 μ s)	I_{max}	150kA
Nominal discharge current (8/20 μ s)	I_n	50kA
Lightning impulse current (10/350 μ s)	I_{imp}	50kA
Voltage protection level (In)	U_p	<1300V
Response time	t_A	<25ns

Indication Specifications

Display		Mechanical flag
Alarm		SPDT power and thermal failure
Alarm isolation		4kV

Mechanical Specifications

Minimum operating temperature		-40°C
Maximum operating temperature		70°C
Minimum operating humidity		5%
Maximum operating humidity		95%
Mounting method		TS35 DIN Rail
Environmental rating		IP20
Enclosure material		Thermoplastic
Enclosure finish		Textured Black
Terminal capacity - power		35mm ²
Terminal screw torque - power		2Nm
Terminal capacity - alarms		1.5mm ²
Terminal screw torque - alarms		0.5Nm
Length		91mm
Width		108mm
Height		67mm

Standard Specifications

IEC 61643-11	SPD connected to low-voltage power systems - Type 1
AS 1768	AC power system SPD - Cat C
UL 1449	Low voltage SPD - Type 2
IEEE 62.41.2	Low voltage SPD - Cat B

Shipping Specifications

Weight		700g
Customs tariff		85363000, 85363010

Other Specifications

Product Code		SG3-50-275
--------------	---	------------