

## RJ45-24CAT6

### Local Area Network Protectors

Novaris network protection products are designed for the protection of equipment connected to twisted pair network cabling systems. They are compliant with CAT5, CAT6 and CAT6A cabling standards.

### 10kA Front End Protection & Low Impedance Secondary Protection

The RJ45-CAT6 protection products employ a 10kA Gas Discharge Tube per signal pair to dissipate the energy associated with large common mode surges. The silicon based secondary protection element used on each signal pair provides exceptional protection for your equipment whilst allowing network speeds up to Gigabit/1000BaseT.

### PoE, PoE+, High Power PoE and beyond

The RJ45-CAT6 protection devices are compliant with PoE standards and can pass up to 1A of current per signal pair at up to 80VDC. This combination allows for Gigabit PoE systems with 4 pair power up to 160W.

### UTP and STP cabling compatible

Novaris network protection products utilise shield pass through connectors and metal bodies to allow for uninterrupted shielded network spans. The RJ45-1CAT6-EC90 option is necessary for earth isolation at the remote end of a network. This prevents current loops from appearing on the network shield.

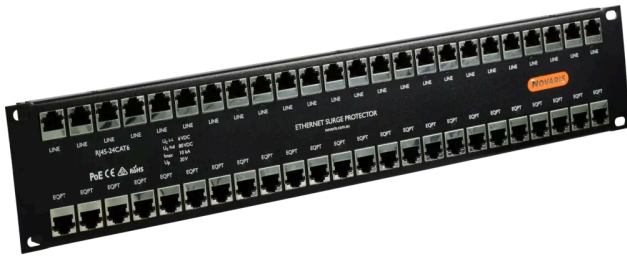
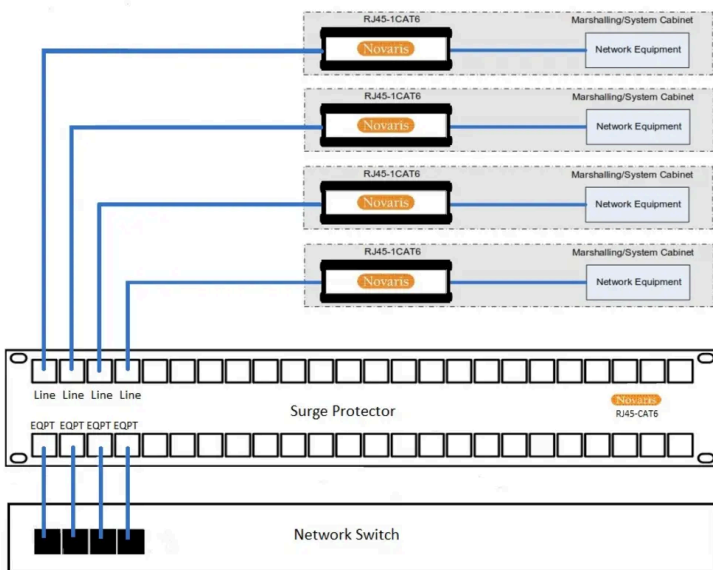
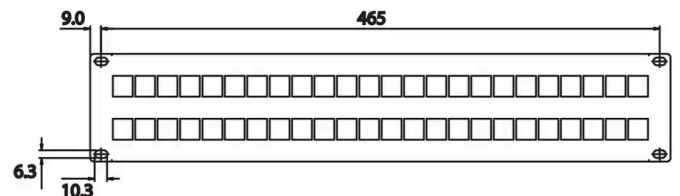

Image for illustrative purposes only

## Wiring







## Dimensions



## Product Datasheet

## Electrical Specifications

Connection type		Series
Number of lines		24 x RJ45 / 4 pairs & shield
Modes of protection		Transverse and Common
Maximum continuous voltage (DC)	$U_c$	6V
Maximum continuous voltage (AC)	$U_c$	4V
Maximum PoE voltage		80VDC
Maximum discharge current (8/20 $\mu$ s) (L-L)	$I_{max}$	5kA
Maximum common mode discharge current (8/20 $\mu$ s) (CM)	$I_{max}$	10kA
Maximum discharge current (10/350 $\mu$ s)	$I_{imp}$	1kA
Maximum common mode discharge current (10/350 $\mu$ s)	$I_{imp}$	2kA
Impulse durability C2 10x8/20 $\mu$ s	$I_n$	1.5kA
Impulse durability D1 2x10/350 $\mu$ s		0.5kA
Maximum load current	$I_L$	1A
AC durability 5x1s		1A rms
Overstressed fault mode		Mode 3
Line resistance		0.1 $\Omega$
Line inductance		0.2 $\mu$ H
3 dB Frequency @ 150 $\Omega$		250MHz
Earthing		Earth terminal
Attenuation @220MHz		1.7dB
NEXT @250 MHz		35.8dB
Return Loss @ 250MHz		11.2dB
Speed		>1 Gbit/s











## Electrical (L-L) Specifications

Voltage protection level @ 1 kV/ $\mu$ s	$U_p$	20V
Voltage protection level @ 100 V/ s		9V
Capacitance	- +	1pF
Response time	$t_A$	1ps

## Electrical (L-PE) Specifications

Voltage protection level @ 1 kV/ $\mu$ s	$U_p$	350V
L-PE Voltage protection level @ 1.5 kA 8/20 $\mu$ s		750V
Voltage protection level @ 100 V/ s		230V
Capacitance	- +	<2pF

## Mechanical Specifications

Minimum operating temperature		-40°C
Maximum operating temperature		70°C
Minimum operating humidity		5%
Maximum operating humidity		95%
Mounting method		Rack mount
Environmental rating		IP20
Enclosure material		Steel
Enclosure finish		Black powdercoat
Terminal type		RJ45 Socket
Length		483mm
Width		20mm
Height		88mm

## Standard Specifications

IEC 61643-21	SPD connected to telecommunications and signalling networks - Cat C2, D1
AS 1768	Signalling/Telecommunications surge protection
UL 497B	Protectors for data, communications and fire-alarm circuits
ITU-T K.44	Resistibility tests for telecommunication equipment exposed to overvoltages and overcurrents
AS/CA S008	Requirements for Customer Cabling Products
AS/NZS 4117	Surge Protective Devices for Telecommunications Applications
AS/CA S009	Installation requirements for customer cabling (Wiring rules)

## Shipping Specifications

Weight		2kg
Customs tariff		85363000

## Other Specifications

Product Code		RJ45-24CAT6
--------------	---	-------------