

### SDN3-150-275

#### All Mode Surge Diverter

Use MULTIMOV all mode high energy surge diverters for point of entry protection at main switchboards, especially where N-PE protection is required.

#### Redundant Segments

MULTIMOV surge diverters feature a parallel redundant arrangement of high energy metal oxide varistors (MOVs), thus promoting long life and exceptional surge handling capacity. In the event of a varistor failure the remaining segments continue to provide protection.

#### LED Status Active Display

The LED display indicates segment status and indicates normal operation when all LEDs are brightly lit. An extinguished LED phase segment indicates the failure of an external backup fuse, a component failure or thermal overload, activating the external alarm.

#### Safe Metal Enclosure

Novaris power protection products are housed in safe, all metal enclosures. In the event of a prolonged overvoltage they will not catch fire or explode.



Image for illustrative purposes only

The colour of the grommets will change starting from 2026. All phases will be black, neutral will be black, and earth will be green

### Wiring

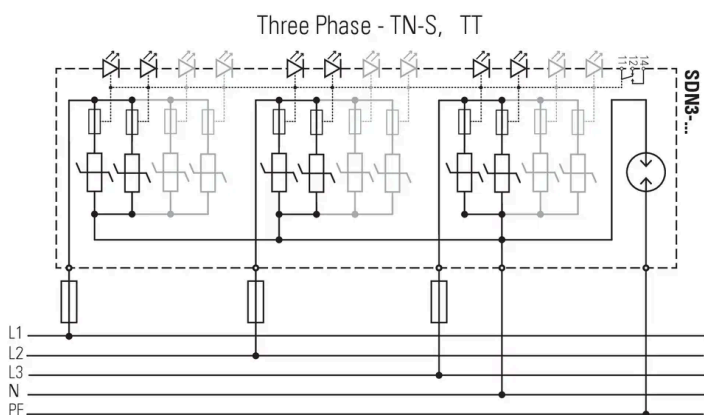



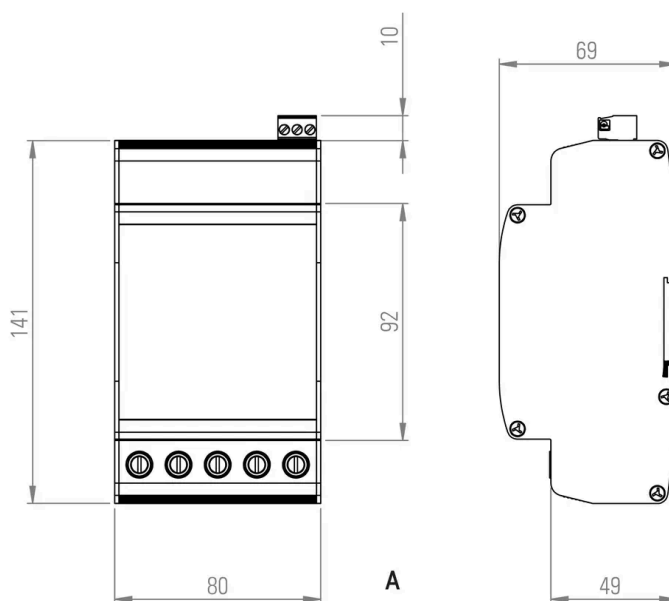

### Dimensions



## Product Datasheet

## Electrical Specifications

Connection type		Shunt
Modes of protection		L-N, L-PE, N-PE
Number of ports		1
Number of phases		3
Location		Indoor
Nominal voltage	$U_0$	230VAC
Short circuit withstand level	$I_{sCCR}$	75kA
Maximum backup fuse		80A
Recommended SCB		SCB1-3-25
Earth leakage current	$I_{PE}$	<10 $\mu$ A

## Electrical (L-N) Specifications

Maximum continuous voltage AC	$U_c$	275VAC
Maximum discharge current (8/20 $\mu$ s)	$I_{max}$	150kA
Nominal discharge current (8/20 $\mu$ s)	$I_n$	60kA
Lightning impulse current (10/350 $\mu$ s)	$I_{imp}$	19kA
Voltage protection level (3kA 8/20 $\mu$ s)	$U_p$	<750V
Voltage protection level (In)	$U_p$	<1450V
Response time	$t_A$	<25ns
Voltage withstand (5s)	$U_T$	335V















## Electrical (N-PE) Specifications

Maximum continuous voltage	$U_c$	255VAC
Maximum discharge current (8/20 $\mu$ s)	$I_{max}$	150kA
Nominal discharge current (8/20 $\mu$ s)	$I_n$	100kA
Lightning impulse current (10/350 $\mu$ s)	$I_{imp}$	75kA
Voltage protection level (1kV/ $\mu$ s)	$U_p$	<1000V
Voltage protection level (3kA 8/20 $\mu$ s)	$U_p$	<1200V
Response time	$t_A$	<25ns
Voltage withstand (200ms)	$U_T$	1200V
Follow current interrupt rating	$I_{fi}$	100A

## Indication Specifications

Display		LED power and thermal failure
Alarm		SPDT power and thermal failure
Alarm isolation		4kV

## Mechanical Specifications

Minimum operating temperature		-40°C
Maximum operating temperature		70°C
Minimum operating humidity		5%
Maximum operating humidity		95%
Mounting method		TS35 DIN Rail/Optional Panel kit
Environmental rating		IP20
Enclosure material		Aluminium
Enclosure finish		Black Powdercoat
Terminal capacity - power		16mm <sup>2</sup>
Terminal screw torque - power		2Nm
Terminal capacity - alarms		2.5mm <sup>2</sup>
Terminal screw torque - alarms		0.5Nm
Length		141mm
Width		80mm
Height		69mm

## Standard Specifications

IEC 61643-11	SPD connected to low-voltage power systems - Type 1, 2
AS 1768	AC power system SPD - Cat C, B
UL 1449	Low voltage SPD - Type 2
IEEE 62.41.2	Low voltage SPD - Cat B

## Shipping Specifications

Weight		870g
Customs tariff		85363000, 85363010

## Other Specifications

Product Code		SDN3-150-275
--------------	---	--------------