

SDN3-100-275



All Mode Surge Diverter

Use MULTIMOV all mode high energy surge diverters for point of entry protection at main switchboards, especially where N-PE protection is required.

Redundant Segments

MULTIMOV surge diverters feature a parallel redundant arrangement of high energy metal oxide varistors (MOVs), thus promoting long life and exceptional surge handling capacity. In the event of a varistor failure the remaining segments continue to provide protection.

LED Status Active Display

The LED display indicates segment status and indicates normal operation when all LEDs are brightly lit. A dim LED phase segment indicates the failure of an external backup fuse and this will activate the external alarm. An extinguished LED indicates a component failure or thermal overload, also activating the external alarm.

Safe Metal Enclosure

Novaris power protection products are housed in safe, all metal enclosures. In the event of a prolonged overvoltage they will not catch fire or explode.

Wiring

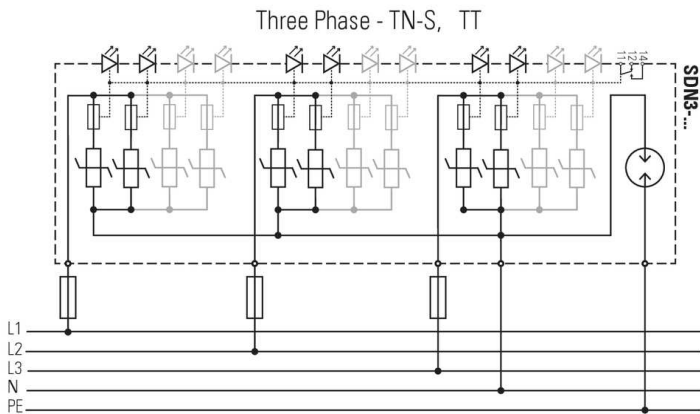

Dimensions

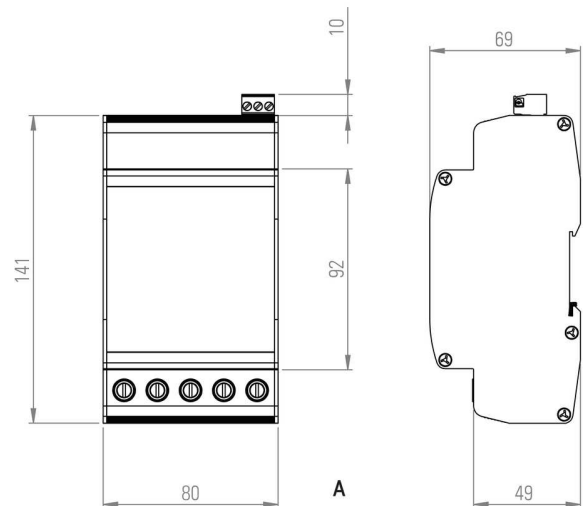





Standards

- IEC 61643-11:2011
- AS/NZS 1768:2007
- UL 1449 3rd edition
- IEEE 62.41.2:2002

- SPD connected to low-voltage power systems - Type 1+2
- A.C. power system SPD - Cat C, B
- Low voltage SPD - Type 2
- Low voltage SPD - Cat B

## Product Datasheet

## Electrical Specifications

Connection type		Shunt
Modes of protection		L-N, N-PE
Number of ports		1
Number of phases		3
Location		Indoor
Nominal voltage	$U_0$	230VAC
Short circuit withstand level	$I_{SSCR}$	25kA
Maximum backup fuse		63A
Recommended SCB		SCB1-3-80
Earth leakage current	$I_{PE}$	<10 $\mu$ A



## Electrical (L-N) Specifications

Maximum continuous voltage AC	$U_c$	275VAC
Maximum discharge current (8/20 $\mu$ s)	$I_{max}$	100kA
Nominal discharge current (8/20 $\mu$ s)	$I_n$	40kA
Lightning impulse current (10/350 $\mu$ s)	$I_{imp}$	12.5kA
Voltage protection level (3kA 8/20 $\mu$ s)	$U_p$	<800V
Voltage protection level (In)	$U_p$	1400V
Response time	$t_A$	<25ns
Voltage withstand (5s)	$U_T$	335V















## Electrical (N-PE) Specifications

Maximum continuous voltage	$U_c$	255VAC
Maximum discharge current (8/20 $\mu$ s)	$I_{max}$	60kA
Lightning impulse current (10/350 $\mu$ s)	$I_{imp}$	50kA
Nominal discharge current (8/20 $\mu$ s)	$I_n$	50kA
Voltage protection level (1kV/ $\mu$ s)	$U_p$	<1000V
Voltage protection level (3kA 8/20 $\mu$ s)	$U_p$	<1200V
Response time	$t_A$	<100ns
Voltage withstand (200ms)	$U_T$	1200V
Follow current interrupt rating	$I_{fi}$	100A

## Indication Specifications

Display		LED power and thermal failure
Alarm		SPDT power and thermal failure
Alarm isolation		4kV

## Mechanical Specifications

Minimum operating temperature		-40°C
Maximum operating temperature		70°C
Minimum operating humidity		5%
Maximum operating humidity		95%
Mounting method		TS35 DIN Rail/Optional Panel kit
Environmental rating		IP20
Enclosure material		Aluminium
Enclosure finish		Black Powdercoat
Terminal capacity - power		16mm <sup>2</sup>
Terminal screw torque - power		2Nm
Terminal capacity - alarms		2.5mm <sup>2</sup>
Terminal screw torque - alarms		0.5Nm
Length		141mm
Width		80mm
Height		69mm

## Other Specifications

Product Code  SDN3-100-275

## Shipping Specifications

Weight		730g
Customs tariff		85363000, 85363010